

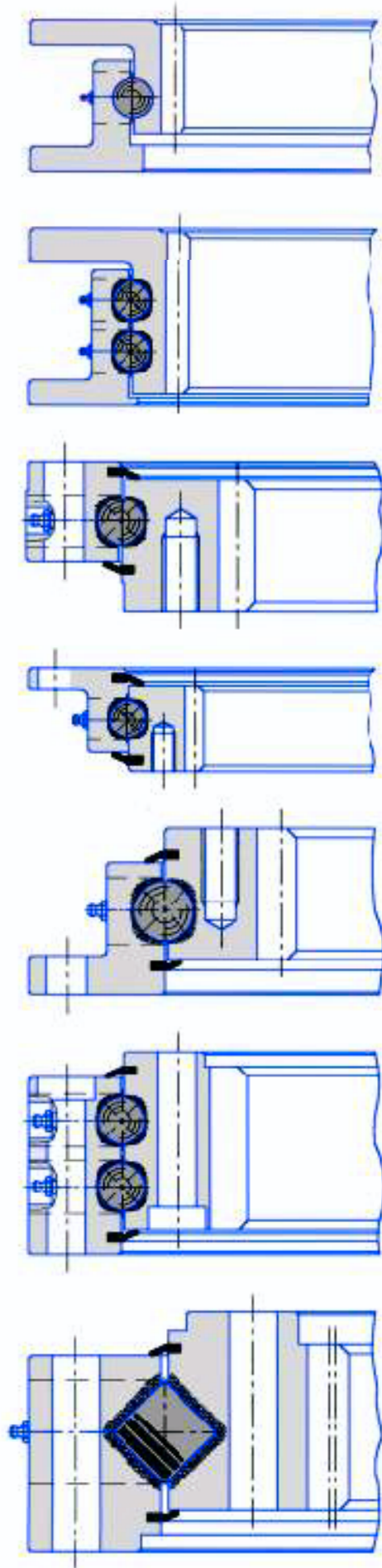

gamma prodotti range of products



Alcune macchine utilizzate per la lavorazione di foratura.
Some machines used for drilling processing.



Alcune macchine utilizzate per la lavorazione di dentatura.
Some machines used for gearing processing.

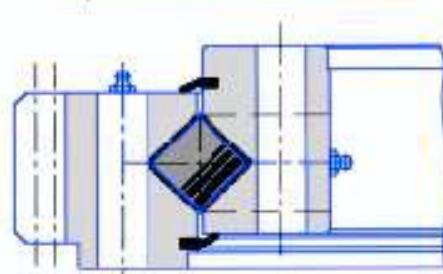
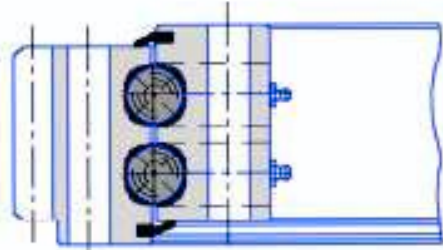
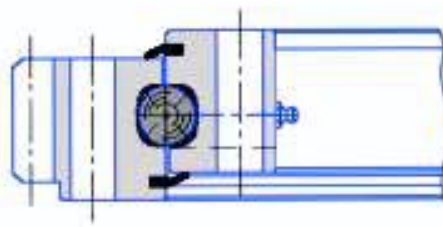
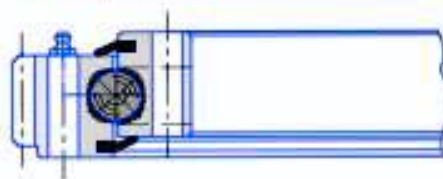
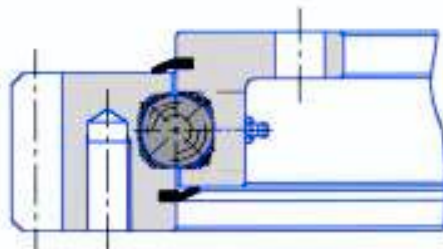
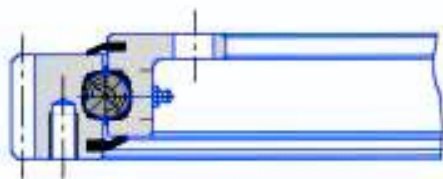
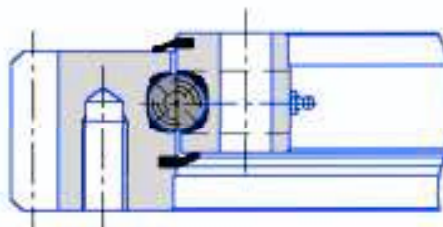
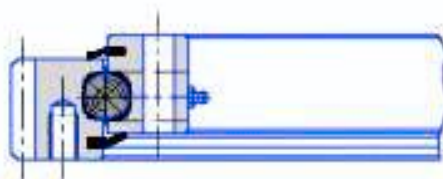

gamma prodotti
range of products



gamma prodotti range of products

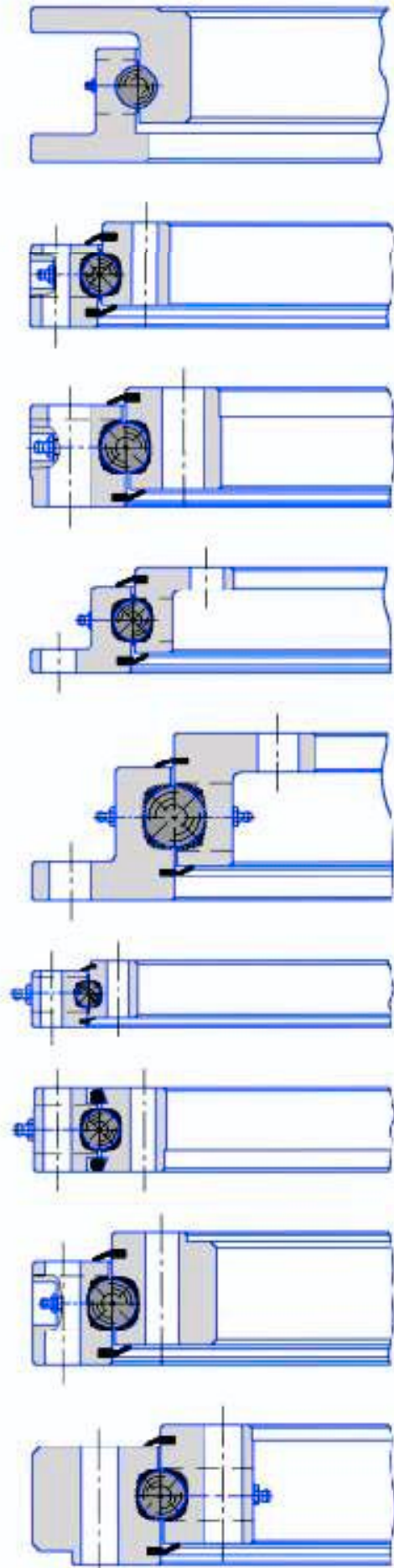

Alcune macchine utilizzate per la lavorazione di tempra.
Some machines used for hardening processing.

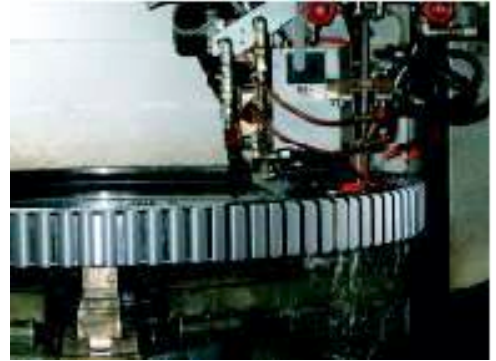

Alcune macchine utilizzate per la lavorazione di torneria.
Some machines used for turning processing.

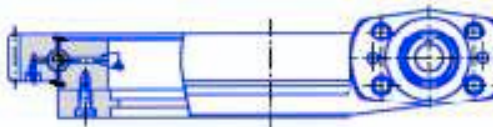
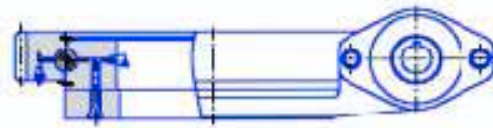
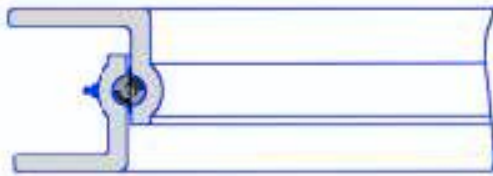

gamma prodotti
range of products